

Pipe inspection system

Operation Manual



Model No. 3199F

Read this Operation Manual carefully before using this tool.



INTRODUCTION

The pipe inspection system is a powerful set of tools that helps you locate and diagnose problems in a pipeline system.

The system is widely used in inspections of Sewer, central air conditioning, chimney, plumbing, building, cable pipe and pipes ventilation systems and other places.

GENERAL SAFETY RULES

PRECAUTIONS

Read all safety warnings and instructions. Failure to follow warnings and instructions may result in electric shock, fire and/or serious injury.



1. Save this operation manual for future reference.
2. Do not operate this device in explosive atmospheres, such as in the presence of flammable liquids, gases, hazardous chemicals, superheated liquid or heavy dust. It may create sparks which may ignite the dust or fumes.
3. The camera head and the push cable are waterproof, however, the battery pack, DVR and connector cable are not. Do not expose them to water or rain. This increases the risk of electrical shock.
4. Avoid using the device in environments of extreme cold, heat or humidity as it may damage the device.
5. Do not drop or press hard on the device.
6. Always backup your data before connecting your SD memory card to this system. The manufacturer is not responsible for any data of damage on your SD memory card for any reason.
7. Do not disconnect the unit while recording or playing back. It may damage the unit and/or the SD memory card.
8. Only qualified person are allowed to repair this device. Service or maintenance performed by unqualified person could result in injury.
9. Do not use this device in places where there is high voltage equipment. The device doesn't contain high voltage protection and isolation.
10. Check or maintain this device regularly, repair it or replace new parts if there is any damage.

APPLICATION AND KNOW YOUR TOOL

APPLICATION

Suitable for pipes at diameter of 25mm-200mm. Ability to go through 90° bend places with diameter at 50mm.

KNOW YOUR TOOL

The pipe inspection system includes the following four main parts: Camera head, cable reel, battery pack and DVR.

The camera head includes 12 high-light white LEDs and a highly scratch-resistant sapphire lens cover; this coupled with stainless steel housing allow the camera to withstand repeated hits in various pipes.

Flexible stainless steel spring and associated components make the camera head possible to go through bend pipes. Also the cable reel is mounted and rotatable in the case therefore the fiberglass rod cable can be pushed in and out without the need to hold the reel. Further, the battery pack provides power supply for the system and the DVR monitor can record video and take photos.

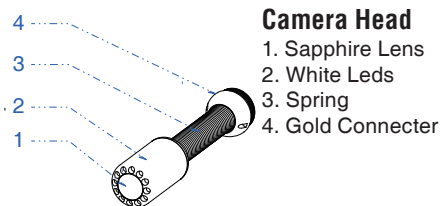

Camera Head

1. Sapphire Lens
2. White Leds
3. Spring
4. Gold Connector

Figure 1. Camera Head

Cable wheel and push cable

1. Rotation Mechanism
2. Handle
3. Cable Connector (To Camera)
4. Cable Wheel
5. Push Cable

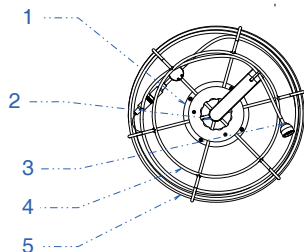

Figure 3. Cable wheel and push cable

Remote control

1. Menu: Select Menu
2. Playback: Playback Mode
3. Pt/Wt: Reserve Function
4. Exit: Exit Menu
5. Up: Select Up/Previous Item
6. OK & Home: Confirm/Select Menu
7. Left: Select Left Item
8. Right: Select Right Item
9. Down: Select Down/Next Item
10. Mirror: Mirror And Flip Image
11. LED: Adjust The Led Brightness
12. REC: Start/Stop Recording
13. Photo: Take Phone

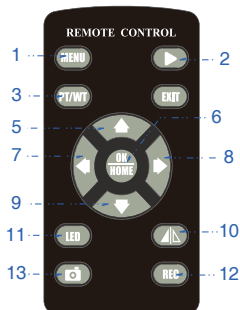

Figure 2. Remote control

Battery Pack

1. LED (battery level indicator)
2. Power Switch
3. DC 12V Recharging
4. Fuse
5. USB Output (DC 5V)
6. DC 7.4V Output



Figure 4. Battery pack

DVR AND TOOL BOX

1. Playback: Playback Mode
2. Left: Select Left Item
3. Menu: Select Menu
4. Power Indicator LED
5. Exit: Exit Menu
6. OK & Home: Confirm/Select Menu
7. Down: Select Down/Next Item
8. LED: Change The Led Brightness
9. IR For Remote Control
10. REC: Start/Stop Recording
11. Power Switch
12. Right: Select Right Item
13. Photo: Take Photo

14. USB 2.0 To PC
15. SD Card Slot
16. Mirror: Mirror And Flip Image
17. Up: Select Up/Previous Item
18. Pt/Wt: Reserve Function
19. Color TFT LCD
20. Sun Visor
21. DC In
22. Camera Head
23. Battery Box
24. Adapter & Car Charger
25. DC 12V Cable
26. Remote Control
27. Aviation Socket
28. Video & Audio Out

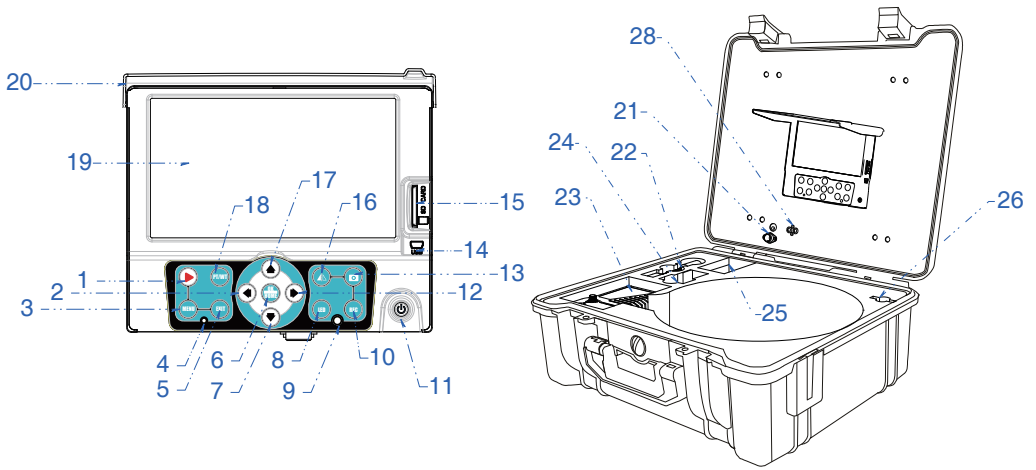

Figure 5. DVR AND TOOL BOX

Package Contents

1. Toolbox with DVR
2. Remote control
3. Cable wheel and push cable
4. Operation manual
5. Battery pack and cable
6. Fuse (2x)
7. 46 Support guides
8. 80 Support guides
9. Car charger
10. Camera
11. Screw (2x), nut (2x) and waterproofing-ring
12. Adapter
13. Screw Driver

Optional Part

- 1 Text writer: Part 3-423
- 2 Meter counter: Part 4-512

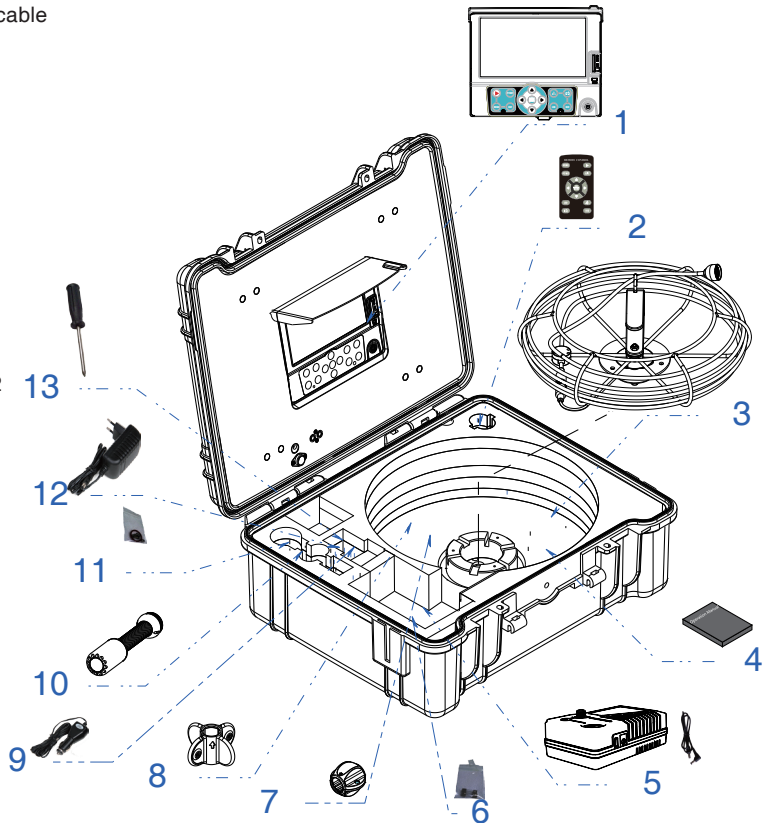

Figure 6. Package Contents

DESCRIPTION SPECIFICATIONS AND STANDARD EQUIPMENT

SPECIFICATIONS

	ITEM	PARAMETER
General	Operating Temperature	-10°~50°/+14°~+122°
	Operating Humidity	30%RH~90%RH
	Storage Temperature	-20°~60°/+4°~+140°
	Power adapter	Input:110VAC~240V AC, Output:12V DC 1200mA
	MEAS.	53.5x23x47cm (LxWxH)
	Weight	10Kg(Approx)
Camera	Sensor	1/3" Sony CCD
	TV-Line	480 TV-Line
	View Angle	135°
	Focus Distance	20cm (approx)
	Depth Of Field	100cm(approx)
	Camera Size	∅ 23mmx45mm (Main body)
	Camera Length	120mm or 250mm
	Front Lens	Sapphire
	Shell Material	304#Stainless Steel
	Lighting	Built-in 12xLED (White)
	Water-Proof	20m water (Camera fix on Cable)
	Power Supply	DC12V
Current Consume	60mA (LED OFF) " 140mA (LED ON)	
DVR	Screen	7-inch 16:9 super bright high-definition color LCD screen
	Resolution	800x480 RGB
	Mirror and Flip	Support image mirror, Flip, Mirror & Flip
	Video Resolution	PAL 720x576 25FPS Max NTSC 720x488 30FPS Max
	Video Encoding	H.264
	Photograph	720x480/720x576
	Audio Recording	Local Sound
	Out Put	TV and Audio output
	External Memory	Support SD Memory Card up to 32GB
	Data Output	USB2.0 To PC
	LED Driver	Built-in Dimmer
	Play Back	Video, Photo and Audio
	Language	English, German, French, Spanish, Italian, Chinese, Japanese, Russian, Portuguese
	Power Supply	DC 6~12V input
Current Consume	700mA Max	
Battery pack	Power Input	DC 9~12V input
	Battery Capacity	7.4V 6600mAh Li-ion Battery
	Power Output	6~12V DC " 5V DC
	Life Time	7 hour (Record) ,9 hour (Play Back)
	Charge Time	8 hour
Cable Wheel	Cable Diameter	∅ 5.2mm
	Cable Length	20/30/40 meter (Selectable)
	Meter Counter	Selectable
Tool Box	Size	517x434x200mm(LxWxH)
	Box color	Black /Yellow (Selectable)

INSTALLATION

WARNING

To reduce the risk of serious injury during use, follow these procedures for proper assembly.

1. INSTALL CAMERA HEAD

Put the cable into the hook of the handle, (Figure 7.) Hold the cable connector in one hand, then screw the camera and fix it on the cable tightly. (Figure 8.)

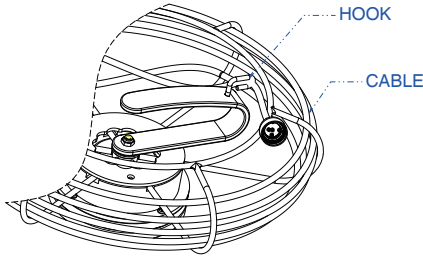

Figure 7. Cable reel in the case

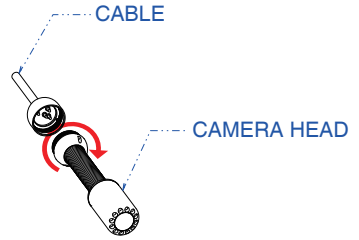

Figure 8. Assembly/Disassembly Camera

2. INSTALL AVIATION CABLE

Plug the cable into the socket of the panel and screw tightly. (Figure 9.)

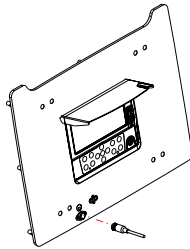

Figure 9. Install aviation cable

3. INSTALL POWER CABLE

Connect the power cable to battery and panel. (Figure 10.)

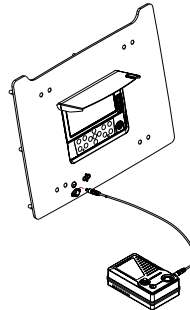

Figure 10. Install power cable

4. INSTALL GUIDE FITTING

Support Guide are designed to help position the camera towards the middle of the pipe. There are 2 kinds of guides, choose guides properly per application requirement.

A. Installing 46 Support Guides.

Sleeve the camera heads with 46 Support guide. (Figure 11.)

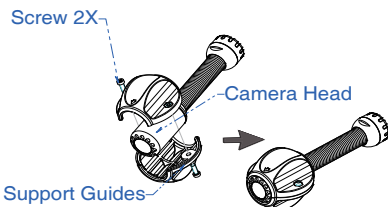

D46 Applicable to 2"-3.5" pipe.

Figure 11. Install 46 Support Guides

B. Install 80 Support Guides.

Mount the 80 support guide onto the stainless steel camera head. Then tighten the screw by screwdriver. (Figure 12.)

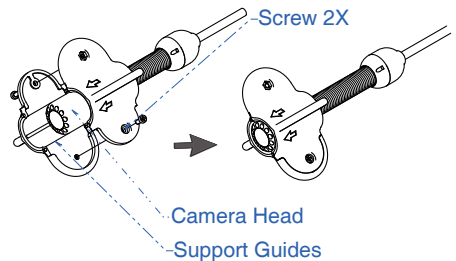

D80 Applicable to 3.5"-5" pipe.

Figure 12. Install 80 Support Guides

5. INSTALL SD CARD

(Figure 13.)

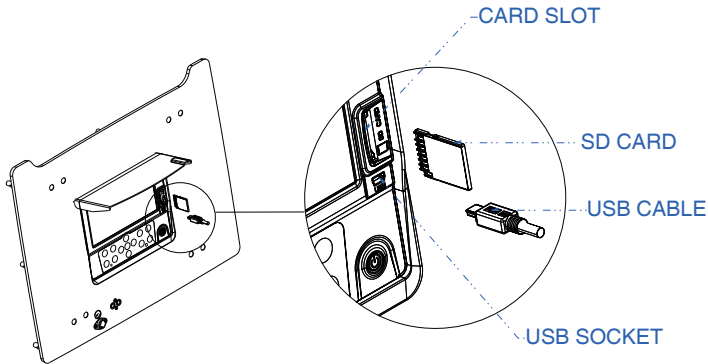

Figure 13. Install SD Card

6. TURN ON THE BATTERY PACK AND DVR.

FUNCTION GUIDE AND OPERATING INSTRUCTIONS

DVR ICON

1. SD Card
2. Battery Level
3. Image Reverse
4. Image Reverse & Mirror
5. Image Mirror
6. Timestamp
7. LED Brightness
8. Record
9. Meter Counter (optional function)

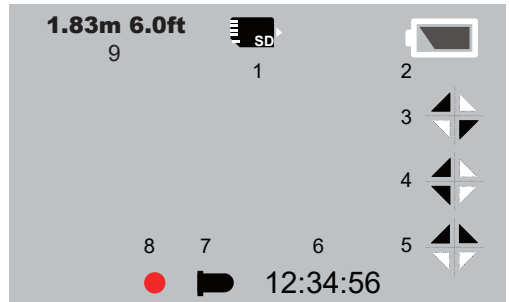



Figure 14. Screen icon Definition

FUNCTION GUIDE

1. Live video

Press [] to turn on/off DVR to enter the live video mode, then press [] to enter playback mode.









Press [] to start/stop recording.

Press [] to mirror or/and reverse the image.

Press [] adjust the brightness of camera LEDs.

Press [] to take a picture.

2. Video Option

Press [] to enter the video option menu. Press [] and [] to select items that you need, press [] to confirm the selection. Press [] or [] to change the value. Press [] to save the setting. Press [] to exit video option and save.





- Size D1 (720*576) / VGA (640*480) / QVGA (320*240)
- Video Seg: 10min/20min/30min/40min/OFF. Set 10-40min to restrict files length and open cycle-cover. Elder files will be covered by new files when SD card is full. Set OFF to close this function.

- Meter Counter: Reserve function.
- Sound: Turn on/off the local sound in Video Recording.
- Timestamp: Enable/Disable time stamp on screen.

3. Playback

Press [] the button to enter the playback, the user can browse, preview and playback media files.





Press [] and [] to browse and select media files.

Press [] to confirm the selection and preview media file. Press [] to preview the previous file. Press [] to preview the next file. Press [] to playback video.



Press [] to enter the play setting.

- Delete: Delete media files.
- Slide Show: 3sec/5sec/10sec. To set interval time of the slide shows.
- Protection: To protect important media files.
- Thumbnail: Browse 9 media files per page.
- File List: Browse 3 media files per page.
- LCD: LCD brightness.

4. Playing Movie

[] Pause/Play movie, [] Stop play movie, [] Rewind, [] Forward, you can press [] to set speed rate of rewind/forward.

5. SETUP

Press [] to enter the preferences of Record/Playback. Press [] enters Setup menu.

The following items are in the setup menu.

- Format: format SD card.
- LCD: LCD brightness.
- Language: English, German, French, Spanish, Italian, Chinese, Japanese, Russian, Portuguese.
- Sys. Reset: Reset all setting.
- Light frequency, 50Hz/60Hz, specifying your ambient light frequency.
- TV output: PAL/NTSC.
- Date input: To set date and time.

AT THE JOB SITE

1. Always wear rubber gloves to operate the camera for health and safety reasons. Properly positioning the cable reel will save time and strength to push out and in the cable, and minimize the rate of equipment damage.
 - When pushing, the end of your stroke should be as close to the entry as possible. Standing too far back with an excess of cable between your hands and the entry may cause the cable to fold on itself outside the entry and damage the cable.
 - Try to keep the push cable away from sharp edge of a pipe entry because this may cause damage. If the camera does not seem to go any farther, DO NOT FORCE TO PUSH THE CAMERA! Try another entry if possible.

NOTE! Hands should be close to the line opening. DONOT catch the cable on the edge of an entry and continue to push.

2. Always try to run water down the pipe under going inspection. This will keep the system much cleaner, and allow you to push noticeably farther with less friction. If the water is preventing you from seeing an area of importance, temporarily turn it off.
3. When push the push cable through the pipeline by steady and slowly, a short distance entry per time, keeps the hands at the entrance, so that can control the push cable and prevent it stuck, bent or scratch.
4. When inspecting a pipe, most of the time a slow steady push through the system works the best. At changes in direction such as P-traps, Tee's, Y's, Elbows, etc. It is usually necessary to give a little extra push in the bends. Back the camera head approximately 8" (20cm) from the bend, if necessary, and give it a quick push, "popping" the camera through a turn, using the least amount of force required. Try to be as gentle as possible, and do not hammer or snap the camera head through corners. After some practice, you may learn that the best way to inspect a section of pipe is to push the camera through quickly. Then draw the camera back home slowly and evenly.
5. Make sure the sapphire window is clean prior to entry. Some users claim that a slight film of detergent on the lens minimizes the possibility of grease sticking to the port. If necessary, take advantage of any standing water in the pipe to wash the front of the camera by jiggling it in the water.
6. When you place the camera head into the pipe remember, as the materials of pipe vary, it will be necessary to adjust the lighting settings to maximize picture quality.
7. The system can travel through multiple 45 and 90 degree bends and wyes. Do not, however, try to force it through a P-trap or tee if there is a large amount of resistance.

NOTE! Do not try to use the camera head to clear obstructions. This System is a diagnostic tool, not a drain cleaner. Using the camera head to clear obstructions could damage the camera head or cause it to be caught in the obstruction.

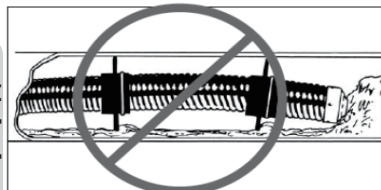

Figure 15. Improper operation

8. Do not attempt to remove or stores push cable on the reel solely by turning the reel itse lf. You can manually push or pull cable from the reel and wind or unwind it.
9. If the camera sits in a pipe, or an enclosed environment, heat will build-up. This may lead to the camera head overheating which will cause fuzzy lines to appear on the monitor. In the event, this happens, turn off the system, remove the camera from the pipe (or enclosed environment) and let the camera head cool for 10 to 15 minutes. Running water into the line will also help cool the camera head. Always use the minimum illumination required to maximize picture quality and to avoid excessive heat build-up.

NOTE! The camera head can get HOT! When finished with your inspection, or if taking a prolonged break in the middle of the inspection, turn off the system.

RETRIEVING THE PUSH CABLE

1. Once the inspection has been completed, pull the push cable back with slow, steady force. Do not force the push cable or exert excessive force. This could damage the camera or push cable. The push cable may get hung up while being retrieved, and may need to be manipulated as did during insertion.

2. Once the inspection has been completed, pull the push cable back with slow, steady force. Do not force the push cable or exert excessive force. This could damage the camera or push cable. The push cable may get hung up while being retrieved, and may need to be manipulated as did during insertion.

Note! NEVER USE SOLVENTS to clean any part of the system. Substances like acetone and other harsh chemicals can cause cracking of the camera ring, which could affect waterproofing.

3. Storing the push cable into the cable reel. One hand holds the push cable, the other hand close to the cable wheel. Slowly and gently push the push cable slide via the hook of the handle, cable reel will rotate and store the push cable inside.

Note! The hands should be close to the cable wheel when storing the push cable. Push the push cable a small piece every try. Push a long distance can cause the push cable bend or broken.

BATTERY PACK SAFETY AND USING GUIDE

USING SAFETY

Read the following battery precautions before using the battery and charger, to reduce the risk of electrical shock.

1. Recharge batteries with accessory charging units.
2. Check the power units and battery pack every time before using the equipment, be sure no problem, use of unauthorized parts may result in electrical shock, fire and/or serious personal injury or damage other instruments and system.
3. Never connects the car charger to any 24 volt cigarette lighter slot. It will harm the battery pack and DVR.
4. Do not short circuit, it may cause fire, electrical shock.
5. Do not charge the battery under rain or wet conditions. Water entering the charger will increase the risk of electrical shock.
6. If the charger and battery are damaged, do not use or stop to charge. It may cause electrical shock.
7. Don't disassemble the battery and case of power adapter, only qualified repair person can repair and maintenance.
8. Properly dispose of the battery. Exposure to high temperatures can cause the battery to explode. So do not dispose of in a fire. Some countries have regulations concerning battery disposal. Please follow all applicable regulations.
9. Do not touch anything which out from battery, which would burn or damage the skin, once touches please flush with water. If in eyes, immediately get medical help fast.

USING GUIDE

Follow the steps as below to reduce the injury of the electric shock.

1. Plug the power adapter to the AC outlet, and insert the other end into the DC inlet on top of the battery pack, charging LED will be red during charging, will be turned to green when charged fully. If battery empty for a long term, it will pre-charge the battery automatically in 10 minutes, and charging LED will be blinking in red.
2. Turn on the power of the battery pack, the battery will supply the system, the battery level will be displayed by the indicator, each green LED indicators mean 25% percent of the battery.

3. It needs about 8 hours to charge the battery fully. The battery can charge online, charging and supplying of work will not increase charging times.

TIPS

User can use a power adaptor or car charger to charge the battery pack. Also can directly supply the system without battery pack.

If no use in a long term, take a recharge per 6 month, to ensure the battery in normal working status.

OTHERS

TROUBLESHOOTING

Problem	Probable fault location	Solution
No Battery level indicate	No power completely	To charge the battery
	Fuse burned	Change the fuse
No image	Cable connection faulty or loosely	Check cable connection, clean and reconnect if necessary
	Camera connector soiled	Clean the camera connector
	Wrong SD memory card	Turu off power and replace SD card
	Wrong setting	Enter the setup menu and select reset

FCC STATEMENT

This device complies with part 15 of the FCC Rules. Operation is subject to the following two conditions:

1. This device may not cause harmful interference.
2. This device must accept any interference received, including interference that may cause undesired operation. Any changes or modification not expressly approved by the party responsible for compliance could void the user's authority to operate the device.

CE

This product complies with standards including Low Voltage Device Directive 73/23/EEC;

EMC

Directive 89/336/EEC. It passed the subject tests by the authority concerned and is authorized to bear CE mark.

Meter Counter User manual (Optional)

SPECIFICATIONS

Item	Parameter
Display length	Meter and Feet
Cable Length	20/30/40 meters (optional)
Accuracy	9cm/0.3Feet
Deviation	±0.7%
Counter Range	0~40 meters
Operating Temperature	-10°~50°/+14°~+122°
Operating Humidity	30%RH~90%RH
Storage Temperature	-20°~60°/+4°~+140°

Features

1. Meter Counter Set
2. Reset Button

Operation

1. Connect the cable on the panel then turn on the screen.
2. Meter will be displayed on screen when pulling out push cable.
3. Press the reset button to set zero.

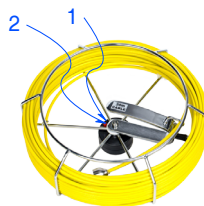

Figure 16. Meter Counter

Note: Connect cable to panel before turning on screen in order to avoid error.

Text Writer User Manual (Optional)

The Text Writer can type in characters to display on screen and record in video files. You can type and edit up to 40 characters.

KEY FEATURE

1. Character key

- 26 English letters.
- 10 Arabic numerals.
- 13 symbols.

2. Function key

- ↵ Enter key, confirm typing.
- DEL Del key, delete character.
- Key, move the cursor to left.
- ← Key, move the cursor to right.
- ⇧ Shift key, switch English letters and Arabic numerals.
- ⇧/AL Caps Lock key, switch capital letters and small letters.



Figure 17. Text Writer

TYPE OPERATION

1. Turn on the screen.
2. Make the Text Writer point to screen then press character keys.
3. Press the same key again to select letters circularly. No operation or press other keys in 2 Seconds to confirm current characters.
4. Press REC key on DVR to record the Video with characters.
5. You can type and edit characters while recording, the typing and editing will be recorded in the video also.

Notes: Reboot the DVR will lose all characters on screen. The characters on screen cannot be recorded on photos.

1-267 Camera (Optional)

Type	Item	Parameter
General	Camera Size	14mm×26mm (Main body)
	Camera Length	80mm
	Power Supply	DC9-15V
	Current Consume	40mA(LED OFF) 60mA(LED ON)
	Water-Proof	10m Water(Camera fix on Cable)
	Shell Material	Aluminum
	Lighting	Built-in 6×LED(White)
	Operating Temperature	-10-50/+14--+122
	Operating Humidity	30%RH-90%RH
	Storage Temperature	-20-60/+4--+140
Image	Sensor	1/4" CMOS
	TV-Line	400 TV-Line
	Pixel	720H x 576V
	View Angle	55°
	Focus Distance	10cm (approx)
	Depth-of-Field	20cm(approx)
	Front Lens	Sapphire

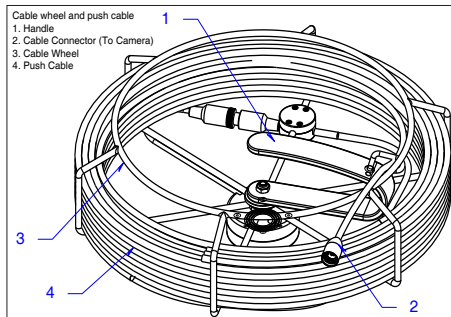
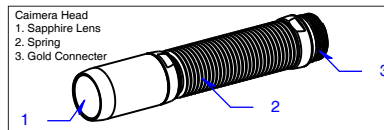

4-523 Cable Wheel (Optional)

Type	Item	Parameter
Cable Wheel	Cable Diameter	φ 4.7mm
	Cable Length	20/30meter (Selectable)
	Meter Counter	built-in

Part Number List

No.	Part Number	Part Name	Specifications	Picture
1	1-201	Camera head	Sony CCD 480TVL, $\Phi 23 \times 120$ mm, 135° View Angle	
2	1-212	Camera head	Sony CCD 480TVL, $\Phi 23 \times 250$ mm, 135° View Angle	
3	2-301	Battery Pack	7.4V 6600mAh Battery,	
4	2-312	Adaptor	DC 12V 1.5A Adaptor	
5	2-323	Car Charger	DC 12V 2A Car Charger	
6	3-412	Remote Control	13 Key Remote Control	
7	3-423	Text Writer	20Key Text Writer	
8	4-501-20 4-501-30 4-501-40	Cable Wheel	Rotatable reel contains $\Phi 5.2$ mm cable. 20, 30, 40M length optional.	
9	4-512-20 4-512-30 4-512-40	Cable Wheel	Rotatable reel contains $\Phi 5.2$ mm cable. 20, 30, 40M length optional. Built-in Meter Counter	
10	5-612	DVR	7-inch Video Recorder, 14Key	
11	6-712	Tool Box	517x434x200mm Tool Box With panel 7-823 and battery pack 2-301	
12	7-823	Panel	470x370mm Panel with DVR 5-612	
13	8-901	Guide	80 Support Guide	
14	8-923	Guide	46 Support Guide	
15	9-001	Maintenance	The parts for fiberglass Connector (10pcs)	

