

KOMATSU

PC
240

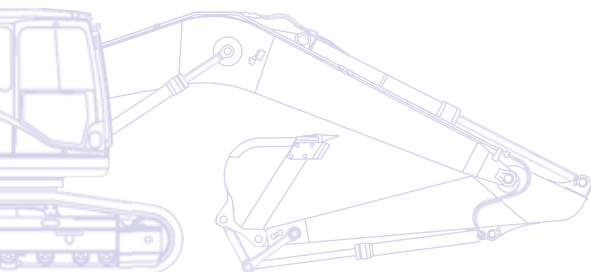

Hydraulic Excavator **PC240LC/NLC-8**



ENGINE POWER

134 kW / 180 HP @ 2.000 rpm

OPERATING WEIGHT

PC240LC-8: 25.200 - 26.630 kg

PC240NLC-8: 24.600 - 25.730 kg

BUCKET CAPACITY

max. 1,89 m³

Walk-Around

The Komatsu Dash 8 crawler excavators set new worldwide standards for construction equipment. Operator safety and comfort is a focal point in their design, and their outstanding performance and specifications will contribute directly to the success of your business. With standard auxiliary hydraulic systems and quick-coupler power lines, these machines are ready to take on any job, whenever and wherever you need it done. Safely rely on Komatsu's 80 years of experience and commitment to Quality and Durability: your Dash 8 crawler excavator will quickly become your number one business partner.

Powerful and environmentally friendly

- Low consumption ecot3 engine
- Komatsu integrated hydraulic system
- Eco-gauge and idle caution
- Reduced wastage

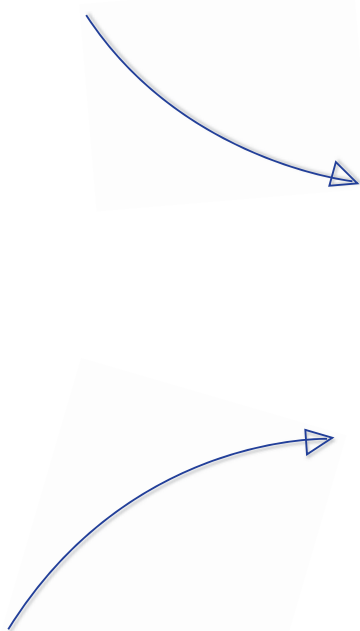

Total versatility

- Ideal for a wide range of applications
- 5 working modes
- Wide choice of options
- Built-in versatility



PC240-8

ENGINE POWER

134 kW / 180 HP @ 2.000 rpm

OPERATING WEIGHT

PC240LC-8: 25.200 - 26.630 kg

PC240NLC-8: 24.600 - 25.730 kg

BUCKET CAPACITY

max. 1,89 m³

Highest safety standards

- Safe SpaceCab™
- Rear view camera
- Optimal jobsite safety
- Safe access, easy maintenance
- Falling Object Protection System (FOPS) optional



First-class operator comfort

- Wide, spacious cab
- Low noise design
- Low vibration levels
- Pressurised cab
- Large, widescreen TFT monitor panel

KOMTRAX

Komatsu Satellite
Monitoring System



Quality you can rely on

- Reliable and efficient
- Rugged design
- Komatsu-quality components
- Extensive dealer support network

Total Versatility

Ideal for a wide range of applications

Powerful and precise, the Komatsu PC240-8 is equipped to efficiently carry out any task your business requires. On big sites or small, for digging, trenching, landscaping or site preparation, the Komatsu original equipment hydraulic system always ensures maximum productivity and control.

5 working modes

Power, Lifting, Breaker, Attachment, and Economy.

The PC240-8 features 5 selectable working modes that optimise performance and fuel usage. The Economy mode can be adjusted for an ideal balance between power and economy to match your work. The oil flow delivered to hydraulic attachments is adjustable directly on the class-leading wide screen monitor panel.



Built-in versatility

To allow the use of many attachments, such as buckets, breakers or demolition tools, a power supply for a hydraulic quick coupler with adjustable pressure settings, and an additional hydraulic circuit controlled by a foot pedal and a sliding joystick push button are standard on the PC240-8. A second optional auxiliary line is also available for attachments that require extra hydraulic actuation.

A wide choice of options

With a choice of different styles of boom, arm and undercarriage, you can configure the PC240-8 to match specific demands for transport, working envelope or duty. The excavator can for instance be equipped with Komatsu's own Super Long Front end equipment, to let the machine work in otherwise inaccessible areas. Extra hydraulic arrangements are available for every boom and arm configuration, making sure that the machine always contributes strongly to your business.





Powerful and Environmentally Friendly

Low consumption ecot3 engine

The Komatsu SAA6D107E-1 engine provides high torque, a better performance at low speed and low fuel consumption. This ecot3 engine features a new combustion chamber design with optimised ignition and combustion timing. The operating pressure of the new common rail system was increased for improved injection and fuel efficiency. The air-to-air charge cooler reduces the temperature of the compressed air supplied by the turbo charger to the cylinders, and further improves fuel consumption.

Meets EU Stage IIIA

The new Komatsu ecot3 engine technology reduces NOx and particle emissions, fuel consumption and noise level. The Komatsu SAA6D107E-1 engine is certified for EPA Tier III and EU Stage IIIA emission regulations. To further reduce the machine's emissions, a Diesel Particulate Filter is also available.

Komatsu integrated hydraulic system

The PC240-8 is a highly responsive and productive machine with all major hydraulic parts designed and manufactured by Komatsu. The electronic Closed Load Sensing hydraulic System (CLSS) offers complete control during individual or combined movements – without sacrificing performance or productivity.

Eco-gauge and idle caution

The unique ECO-gauge helps the operator reduce emissions and fuel consumption for environmentally friendly and energy saving operations. And to further avoid wasting fuel when the machine is not actually working, a standard-fit idle caution is displayed if the engine idles for 5 minutes or more.

Komatsu SAA6D107E-1



Eco-gauge



Idle caution





Reduced wastage

To avoid spillage of excess grease – and prolong the life of your machine – the PC240-8 can be equipped with an automatic greasing system that provides precisely the correct amount of grease when and where it's required.



First-Class Operator Comfort

Wide spacious cab

The newly designed, wide and spacious cab includes a heated air suspension seat with a reclining backrest. The seat height and longitudinal inclination are easily adjusted with a pull-up lever. You can also set the operational posture of the armrest and the position of the console or recline the seat all the way and place it into a fully flat state with the headrest attached.

Pressurised cab

An automatic air conditioner, an air filter and a positive internal air pressure (60 Pa) combine to prevent external dust from entering the cab.

Low noise design

Komatsu Dash 8 crawler excavators feature the lowest in-class external noise levels and are especially well-suited for work in confined spaces or urban areas. Reduced fan speed, a large capacity radiator, and the optimal usage of sound insulation and of sound absorbing materials help to make noise levels inside Dash 8 excavators comparable to those inside an executive car.

Cab damper mounting

The built-in stability of the Komatsu PC240-8, combined with a highly rigid deck and a sprung multi-layer viscous mount system, drastically reduces vibration levels for the operator.



Automatic air conditioner



Hot and cool box



Joysticks with proportional control button for attachments





Large, widescreen TFT monitor

To enable safe, accurate and smooth work, the user friendly monitor is the highly intuitive user interface for the machine's Equipment Management and Monitoring System (EMMS). Multilingual and with all essential information available at a glance, it features simple and easy to operate switches and multifunction keys that provide the operator with fingertip access to a wide range of functions and operating information.





Highest Safety Standards

Safe SpaceCab™

Specifically designed for Komatsu excavators, the Dash 8 cab has a tubular steel frame. It provides very high shock absorbency, impact resistance and durability. The seat belt is designed to keep the operator in the safety zone of the cab in the event of a roll-over. At your request, the Komatsu PC240-8 can also be fitted with an ISO 10262 Level 2 Falling Object Protective System (FOPS).

Safe and easy maintenance

Thermal guards are placed around high temperature parts of the engine. The fan belt and pulleys are well protected and in case of damage, fire risk is reduced by a pump/engine partition that prevents hydraulic oil from spraying onto the engine.

Optimal job site safety

Safety features on the Komatsu PC240-8 comply with the latest industry standards and work together as a system to minimise risks to personnel in and around the machine. An audible travel alarm further promotes job site safety. Very durable anti-slip plates – with additional high friction covering – maintain long term traction performance.

Rear view camera

A standard fitment camera gives an exceptionally clear view of the rear work zone on the wide-screen monitor panel. Large mirrors on both sides ensure that machine visibility meets the latest ISO standards.



Rear view camera

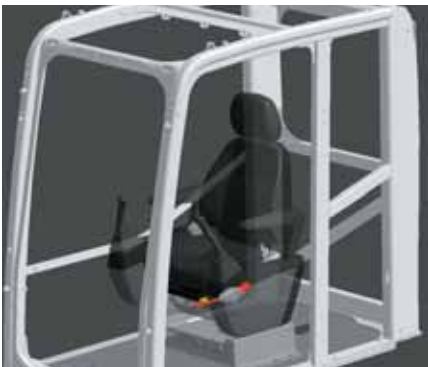

Safe SpaceCab™



Anti-slip plates



Quality You Can Rely On

Reliable and efficient

Productivity is the key to success – all major components of the PC240-8 are designed and directly manufactured by Komatsu. Essential machine functions are perfectly matched for a highly reliable and productive machine.

Rugged design

Maximum toughness and durability – along with top class customer service – are the cornerstones of Komatsu's philosophy. Single piece plates and castings are used in key areas of the machine's structure for good load distribution. Highly durable rubbing strips on the underside of the arm protect the structure from material falling from the bucket.

Komatsu-quality components

With the latest computer design techniques and a thorough test programme, Komatsu's global know-how produces machines that are designed, manufactured and tested to meet your highest standards.

Extensive dealer support network

The extensive Komatsu distribution and dealer network is standing by to help keep your fleet in optimum condition. Customised servicing packages are available, with express availability of spare parts, to make sure that your Komatsu will continue to perform at its peak.



Cast boom foot



Single piece boom plates



Komatsu Satellite Monitoring System



KOMTRAX™ is a revolutionary machine tracking system designed to save you time and money. You can now monitor your equipment anytime and anywhere. Use valuable machine data received via the KOMTRAX™ web site to optimise your maintenance planning and machine performances.

KOMTRAX™ can assist you with:

Full machine monitoring

Get detailed operation data to know when your machines are used and how productive they are.

Total Fleet Management

Keep track of the location of your machines at all times and discourage unapproved usage or theft.

Complete machine status

Receive warnings, alerts and cautions, via a web site or by e-mail, to help with maintenance planning and for longer machine life.

For further details on KOMTRAX™, please ask your Komatsu dealer for the latest KOMTRAX™ brochure.





Machine working time - With the “daily working record” chart, get precise engine running time data: when your machine was started and when it was shut down, as well as total engine running time.

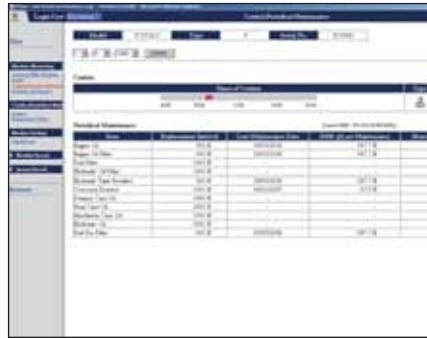

Maintenance planning - To increase productivity and improve maintenance planning, alerts indicate when items such as filters or oil must be replaced.



Fleet location - The machine list instantly locates all your machines, even those in other countries.



Machine tracking during transport - When your machine is transported, KOMTRAX™ sends travel messages to the web site or by e-mail to inform you of its progress, and confirms when it reaches its destination.



Alarm notifications - You can receive notification of alarms both via the KOMTRAX™ website and by e-mail.



Added security - The “engine lock” feature allows to program when a machine’s engine can be started. And with “geo-fence”, KOMTRAX™ sends notification every time your machine moves in or out of a predetermined operating area.



Easy Maintenance

Side-by-side cooling

Since the radiator, aftercooler and oil cooler are arranged in parallel, it is easy to clean, remove and install them.



Easy access to the engine oil filter and fuel drain valve

The engine oil filter and fuel drain valve are mounted remotely to improve accessibility.



Gas-assisted engine hood damper cylinders

The engine hood can be easily opened and closed with help of the gas-assisted engine hood damper cylinders.



Water separator

This is standard equipment which removes any water that has become mixed with the fuel, preventing fuel system damage.



Washable floor

The floor is easy to keep clean. The gently inclined surface has a flanged floormat and drainage holes to facilitate runoff.

Inclined track frame

The track frame is sloped so that dirt will not accumulate and can be removed easily.

Long-life oil filters

The hydraulic oil filter uses high-performance filtering material for long element replacement intervals, which significantly reduces maintenance costs.



Flexible warranty

When you purchase Komatsu equipment, you gain access to a broad range of programmes and services that have been designed to help you get the most from your investment. For example, Komatsu's Flexible Warranty Programme provides a range of extended warranty options on the machine and its components. These can be chosen to meet your individual needs and activities. This programme is designed to help reduce total operating costs.

ENGINE

Model	Komatsu SAA6D107E-1
Type	Common rail direct injection, water-cooled, emissionised, turbocharged, after-cooled diesel
Engine power	
at rated engine speed	2.000 rpm
ISO 14396	134 kW / 180 HP
ISO 9249 (net engine power)	125 kW / 168 HP
No. of cylinders	6
Bore x stroke	107 x 124 mm
Displacement	6,69 ltr
Battery	2 x 12 V/140 Ah
Alternator	24 V/60 A
Starter motor	24 V/5,5 kW
Air filter type	Double element type with monitor panel dust indicator and auto dust evacuator
Cooling	Suction type cooling fan with radiator fly screen

HYDRAULIC SYSTEM

Type	HydrauMind. Closed-centre system with load sensing and pressure compensation valves
Additional circuits	Depending on the specification up to 2 additional circuits can be installed
Main pump	2 variable displacement piston pumps supplying boom, arm, bucket, swing and travel circuits
Maximum pump flow	2 x 219 ltr/min
Relief valve settings	
Implement	380 bar
Travel	380 bar
Swing	295 bar
Pilot circuit	33 bar

UNDERCARRIAGE

Construction	X-frame centre section with box section track frames
Track assembly	
Type	Fully sealed
Shoes (each side)	51 (PC240LC), 49 (PC240NLC)
Tension	Combined spring and hydraulic unit
Rollers	
Track rollers (each side)	10 (PC240LC), 9 (PC240NLC)
Carrier rollers (each side)	2

SWING SYSTEM

Type	Axial piston motor driving through planetary double reduction gearbox
Swing lock	Electrically actuated wet multi-disc brake integrated into swing motor
Swing speed	0 - 11,7 rpm
Swing torque	77 kNm
Max. pressure	295 bar

DRIVES AND BRAKES

Steering control	2 levers with pedals giving full independent control of each track
Drive method	Hydrostatic
Travel operation	Automatic 3-speed selection
Gradeability	70%, 35°
Max. travel speeds	
Lo / Mi / Hi	3,0 / 4,1 / 5,5 km/h
Maximum drawbar pull	20.570 kg
Brake system	Hydraulically operated discs in each travel motor

SERVICE REFILL CAPACITIES

Fuel tank	400,0 ltr
Radiator	20,4 ltr
Engine oil	23,1 ltr
Swing drive	6,6 ltr
Hydraulic tank	135,0 ltr
Final drive (each side)	3,3 ltr

ENVIRONMENT

Engine emissions	Fully complies with EU Stage IIIA and EPA Tier III exhaust emission regulations
Noise levels	
LwA external	103 dB(A) (2000/14/EC Stage II)
LpA operator ear	70 dB(A) (ISO 6396 dynamic test)

OPERATING WEIGHT (APPR.)

	MONO BOOM				TWO-PIECE BOOM			
	PC240LC-8		PC240NLC-8		PC240LC-8		PC240NLC-8	
Triple grouser shoes	Operating weight	Ground pressure	Operating weight	Ground pressure	Operating weight	Ground pressure	Operating weight	Ground pressure
600 mm	25.200 kg	0,51 kg/cm ²	24.600 kg	0,52 kg/cm ²	25.730 kg	0,52 kg/cm ²	25.130 kg	0,53 kg/cm ²
700 mm	25.500 kg	0,44 kg/cm ²	24.900 kg	0,45 kg/cm ²	26.030 kg	0,45 kg/cm ²	25.430 kg	0,46 kg/cm ²
800 mm	25.800 kg	0,39 kg/cm ²	25.200 kg	0,40 kg/cm ²	26.330 kg	0,40 kg/cm ²	25.730 kg	0,41 kg/cm ²
900 mm	26.100 kg	0,35 kg/cm ²	-	-	26.630 kg	0,36 kg/cm ²	-	-

Operating weight, including 3,0 m arm, 1.070 kg bucket, operator, lubricant, coolant, full fuel tank and the standard equipment.

Dimensions & Performance Figures

MACHINE DIMENSIONS	PC240LC-8	PC240NLC-8
A Overall width of upper structure	2.710 mm	2.710 mm
B Overall height of cab	3.055 mm	3.055 mm
C Overall length of basic machine	5.255 mm	5.130 mm
D Tail length	2.905 mm	2.905 mm
Tail swing radius	2.940 mm	2.940 mm
E Clearance under counterweight	1.100 mm	1.100 mm
F Machine tail height	2.405 mm	2.405 mm
G Ground clearance	440 mm	440 mm
H Tumbler centre distance	3.845 mm	3.655 mm
I Track length	4.640 mm	4.450 mm
J Track gauge	2.580 mm	2.380 mm
K Track shoe width	600, 700, 800, 900 mm	600, 700, 800 mm
L Overall track width with 600 mm shoe	3.180 mm	2.980 mm
Overall track width with 700 mm shoe	3.280 mm	3.080 mm
Overall track width with 800 mm shoe	3.380 mm	3.180 mm
Overall track width with 900 mm shoe	3.480 mm	-

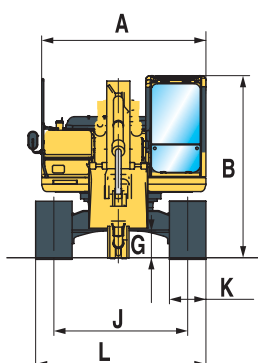

MONO BOOM

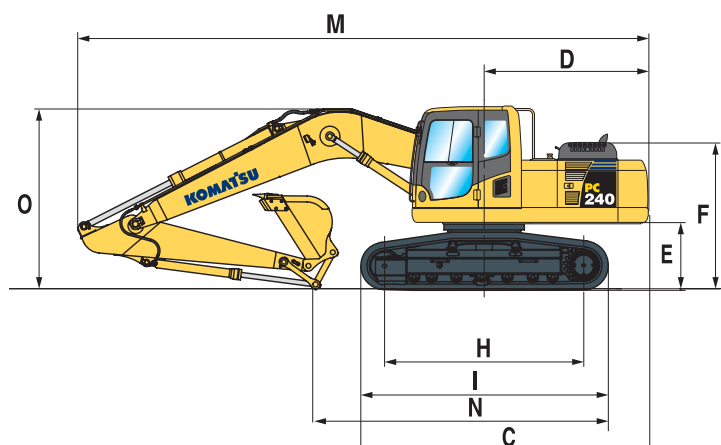

TWO-PIECE BOOM

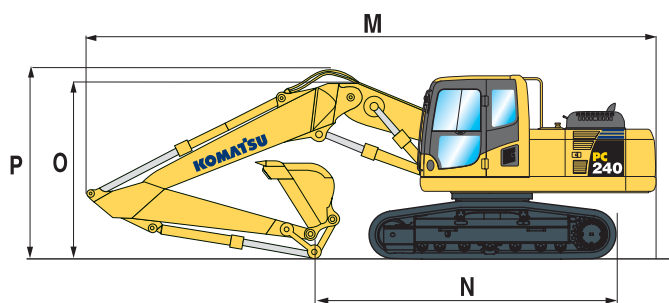

TRANSPORT DIMENSIONS	MONO BOOM				TWO-PIECE BOOM		
Arm length	2,0 m	2,5 m	3,0 m	3,5 m	2,5 m	3,0 m	3,5 m
M Transport length	9.865 mm	9.960 mm	9.885 mm	9.910 mm	10.090 mm	10.040 mm	10.000 mm
N Length on ground (transport) PC240LC	6.600 mm	6.115 mm	5.390 mm	4.950 mm	6.795 mm	6.170 mm	8.895 mm
Length on ground (transport) PC240NLC	6.460 mm	6.020 mm	5.260 mm	4.860 mm	6.700 mm	6.075 mm	5.800 mm
O Overall height (to top of boom)	3.220 mm	3.295 mm	3.160 mm	3.270 mm	3.015 mm	3.015 mm	3.155 mm
P Overall height (to top of hose)	-	-	-	-	3.445 mm	3.540 mm	3.680 mm

**PC240LC-8 / MAX. BUCKET CAPACITY AND WEIGHT**

MONO BOOM								
Arm length	2,0 m		2,5 m		3,0 m		3,5 m	
Material weight up to 1,2 t/m ³	1,89 m ³	1.300 kg	1,89 m ³	1.300 kg	1,89 m ³	1.300 kg	1,82 m ³	1.250 kg
Material weight up to 1,5 t/m ³	1,89 m ³	1.300 kg	1,82 m ³	1.250 kg	1,64 m ³	1.175 kg	1,54 m ³	1.125 kg
Material weight up to 1,8 t/m ³	1,67 m ³	1.175 kg	1,58 m ³	1.125 kg	1,40 m ³	1.075 kg	1,33 m ³	1.025 kg

TWO-PIECE BOOM							
Arm length	2,5 m		3,0 m		3,5 m		
Material weight up to 1,2 t/m ³	1,89 m ³	1.300 kg	1,73 m ³	1.200 kg	1,61 m ³	1.150 kg	
Material weight up to 1,5 t/m ³	1,62 m ³	1.150 kg	1,46 m ³	1.075 kg	1,36 m ³	1.050 kg	
Material weight up to 1,8 t/m ³	1,40 m ³	1.050 kg	1,27 m ³	1.000 kg	1,18 m ³	950 kg	

PC240NLC-8 / MAX. BUCKET CAPACITY AND WEIGHT

MONO BOOM								
Arm length	2,0 m		2,5 m		3,0 m		3,5 m	
Material weight up to 1,2 t/m ³	1,89 m ³	1.300 kg	1,89 m ³	1.300 kg	1,70 m ³	1.200 kg	1,58 m ³	1.125 kg
Material weight up to 1,5 t/m ³	1,70 m ³	1.200 kg	1,59 m ³	1.150 kg	1,44 m ³	1.075 kg	1,34 m ³	1.025 kg
Material weight up to 1,8 t/m ³	1,47 m ³	1.075 kg	1,38 m ³	1.050 kg	1,20 m ³	975 kg	1,16 m ³	950 kg

TWO-PIECE BOOM							
Arm length	2,5 m		3,0 m		3,5 m		
Material weight up to 1,2 t/m ³	1,70 m ³	1.200 kg	1,52 m ³	1.100 kg	1,43 m ³	1.075 kg	
Material weight up to 1,5 t/m ³	1,44 m ³	1.075 kg	1,28 m ³	1.000 kg	1,21 m ³	975 kg	
Material weight up to 1,8 t/m ³	1,25 m ³	975 kg	1,11 m ³	925 kg	1,05 m ³	900 kg	

Max. capacity and weight have been calculated according to ISO 10567:2007.
Please consult with your distributor for the correct selection of buckets and attachments to suit the application.

BUCKET AND ARM FORCE

Arm length	2,0 m	2,5 m	3,0 m	3,5 m
Bucket digging force	18.800 kg	18.800 kg	16.200 kg	16.200 kg
Bucket digging force at PowerMax	20.100 kg	20.100 kg	17.500 kg	17.500 kg
Arm crowd force	15.300 kg	14.100 kg	12.300 kg	10.500 kg
Arm crowd force at PowerMax	16.400 kg	15.100 kg	13.200 kg	11.200 kg

Working Range

MONO BOOM

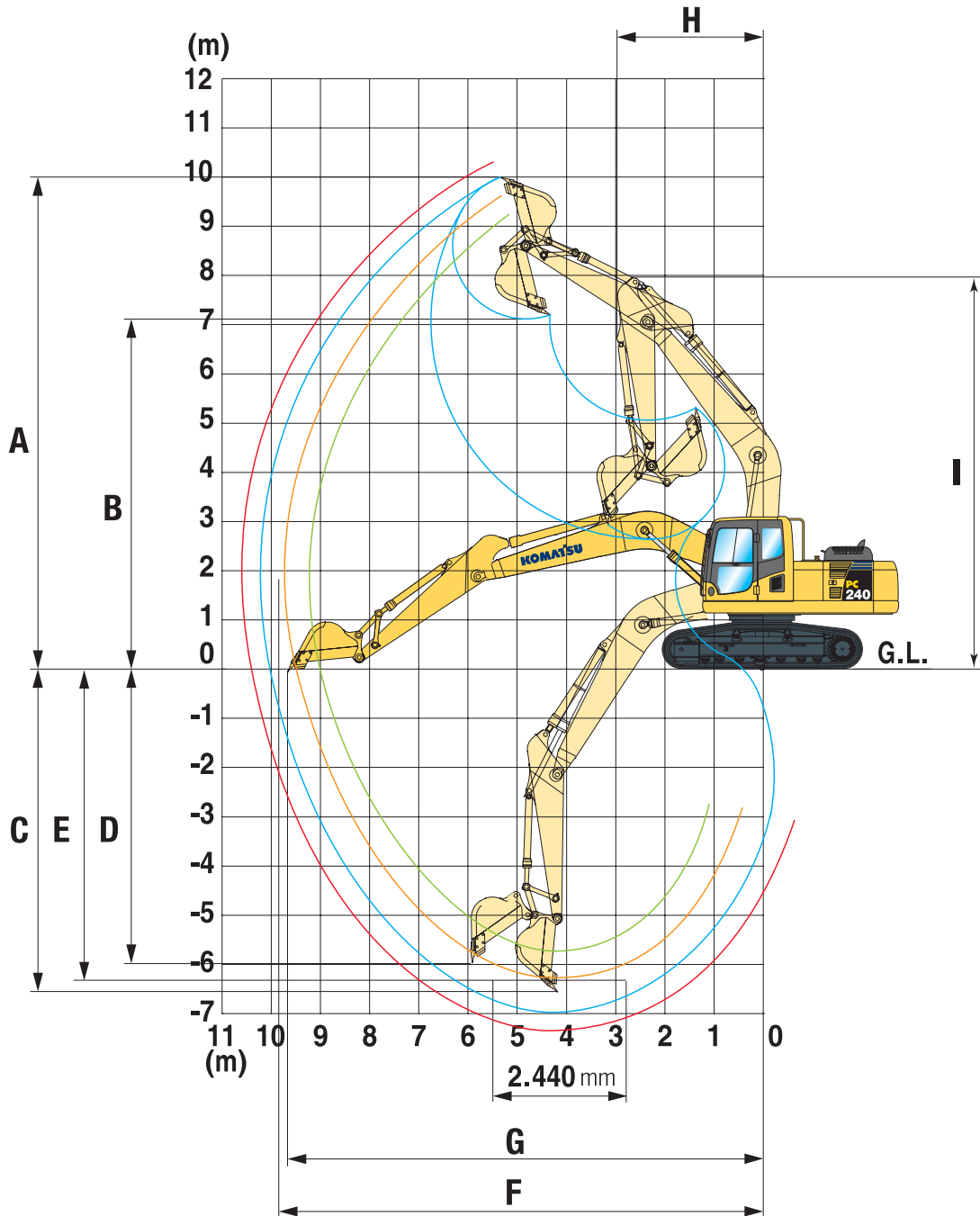

ARM LENGTH	2,0 m	2,5 m	3,0 m	3,5 m
A Max. digging height	9.665 mm	9.790 mm	10.000 mm	10.300 mm
B Max. dumping height	6.715 mm	6.860 mm	7.035 mm	7.360 mm
C Max. digging depth	5.825 mm	6.320 mm	6.920 mm	7.320 mm
D Max. vertical wall digging depth	4.750 mm	5.130 mm	6.010 mm	6.230 mm
E Max. digging depth of cut for 2,44 m level	5.585 mm	6.100 mm	6.700 mm	7.150 mm
F Max. digging reach	9.270 mm	9.480 mm	10.180 mm	10.580 mm
G Max. digging reach at ground level	9.070 mm	9.670 mm	10.020 mm	10.420 mm
H Min. swing radius	3.300 mm	3.320 mm	3.450 mm	3.340 mm
I Max. height at min. swing radius	8.060 mm	8.160 mm	8.110 mm	8.140 mm



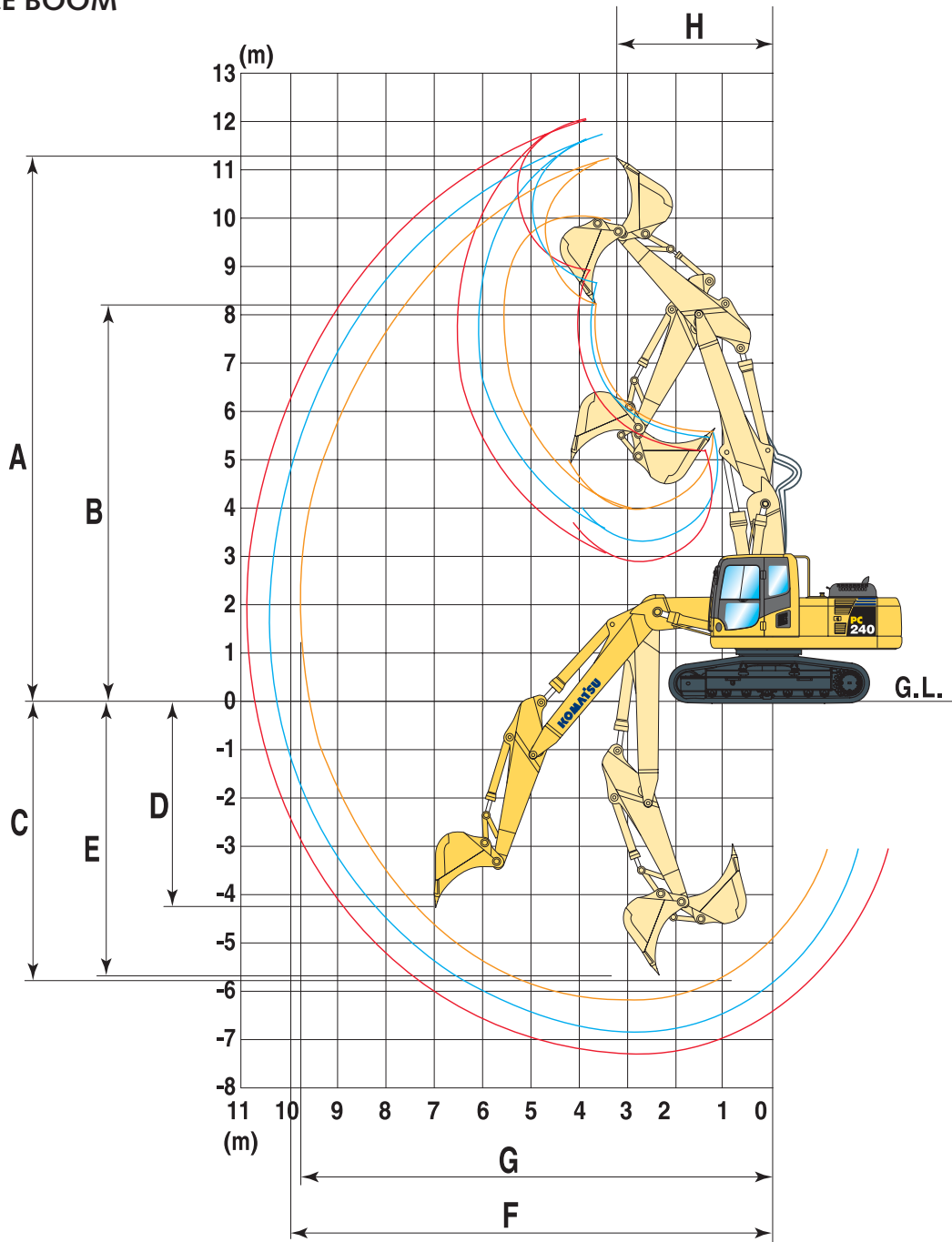















TWO-PIECE BOOM

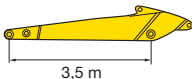

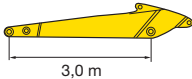
ARM LENGTH	2,5 m	3,0 m	3,5 m
A Max. digging height	11.300 mm	11.800 mm	12.100 mm
B Max. dumping height	8.207 mm	8.702 mm	8.997 mm
C Max. digging depth	6.062 mm	6.601 mm	7.092 mm
D Max. vertical wall digging depth	4.653 mm	5.545 mm	6.003 mm
E Max. digging depth of cut for 2,44 m level	5.962 mm	6.508 mm	7.004 mm
F Max. digging reach	10.000 mm	10.550 mm	10.970 mm
G Max. digging reach at ground level	9.800 mm	10.370 mm	10.800 mm
H Min. swing radius	2.946 mm	2.874 mm	2.984 mm

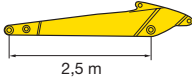
Lifting Capacity

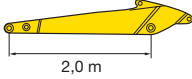
PC240LC-8 MONO BOOM

Arm length	A		7,5 m		6,0 m		4,5 m		3,0 m		1,5 m			
	B													
 3,5 m  0,96 m³	6,0 m	kg	*2.350	*2.350	*4.050	*4.050								
	4,5 m	kg	*2.400	*2.400	*5.050	*4.200	*5.200	*5.200						
	3,0 m	kg	*2.550	*2.550	*5.800	4.050	*6.550	5.950	*8.050	*8.050	*11.850	*11.850		
	1,5 m	kg	*2.850	2.650	6.050	3.850	*8.000	5.550	*10.850	8.750	*10.850	*10.850		
	0,0 m	kg	*3.300	2.650	5.850	3.700	8.400	5.250	*12.900	8.150	*9.500	*9.500	*4.300	*4.300
	-1,5 m	kg	*4.050	2.850	5.750	3.600	8.150	5.000	13.500	7.900	*11.850	*11.850	*7.350	*7.350
	-3,0 m	kg	5.350	3.350	5.700	3.550	8.150	5.000	13.450	7.850	*15.650	*15.650	*10.600	*10.600
-4,5 m	kg	7.050	4.400			8.250	5.100	*13.100	8.000	*19.350	16.500	*14.400	*14.400	
 3,0 m  0,96 m³	6,0 m	kg	*3.000	*3.000	*4.450	4.250	*4.900	*4.900						
	4,5 m	kg	*3.050	*3.050	*5.550	4.200	*5.800	*5.800						
	3,0 m	kg	*3.200	2.950	*6.250	4.050	*7.150	5.900	*9.050	*9.050	*14.450	*14.450		
	1,5 m	kg	*3.550	2.850	6.050	3.850	*8.550	5.550	*11.700	8.650	*6.900	*6.900		
	0,0 m	kg	*4.050	2.900	5.900	3.700	8.450	5.250	*13.500	8.150	*8.100	*8.100		
	-1,5 m	kg	*4.950	3.100	5.800	3.650	8.300	5.150	13.550	8.000	*11.650	*11.650	*7.350	*7.350
	-3,0 m	kg	5.850	3.700			8.250	5.100	*13.600	8.000	*16.750	16.350	*11.350	*11.350
-4,5 m	kg	7.950	5.000			8.450	5.300	*12.650	8.200	*18.350	16.850			
 2,5 m  0,96 m³	6,0 m	kg	*4.750	4.400			*5.650	*5.650						
	4,5 m	kg	*4.850	3.650	*6.100	4.150	*6.500	6.100	*7.500	*7.500				
	3,0 m	kg	5.150	3.300	6.200	4.000	*7.750	*5.800	*10.150	9.100				
	1,5 m	kg	5.000	3.200	6.000	3.850	8.650	5.450	*12.550	8.450				
	0,0 m	kg	5.150	3.250	5.900	3.750	8.400	5.250	13.700	8.100				
	-1,5 m	kg	5.650	3.550	5.850	3.700	8.300	5.150	13.600	8.000	*13.000	*13.000	*8.550	*8.550
	-3,0 m	kg	6.850	4.350			8.350	5.200	*13.700	8.100	*19.850	16.550	*13.900	*13.900
-4,5 m	kg	*9.550	6.400					*11.700	8.400	*16.750	*16.750			
 2,0 m  0,96 m³	6,0 m	kg	*4.850	4.800			*6.300	6.200						
	4,5 m	kg	*4.950	3.950	*5.600	*4.050	*7.100	*6.000	*8.400	*8.400	*12.000	*12.000		
	3,0 m	kg	*5.250	*3.550	6.100	3.950	*8.250	5.700	*11.050	8.850				
	1,5 m	kg	5.350	3.400	5.900	3.800	8.550	5.400	*13.200	8.250				
	0,0 m	kg	5.550	3.500	5.900	3.700	8.350	5.200	*13.600	8.000				
	-1,5 m	kg	6.200	3.900			8.300	5.150	13.600	8.000	*13.550	*13.550		
	-3,0 m	kg	7.800	4.900			8.450	5.250	*13.200	8.150	*18.650	16.750	*16.400	*6.400
-4,5 m	kg	*9.750	7.850					*10.450	8.550					

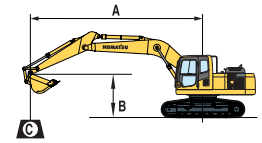

A – Reach from swing center

B – Bucket hook height

C – Lifting capacities, including bucket (730 kg), bucket linkage (200 kg) and bucket cylinder (140 kg)

 – Rating over front

















 – Rating over side

 – Rating at maximum reach

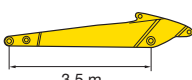
When removing bucket, linkage or cylinder, lifting capacities can be increased by their respective weights.

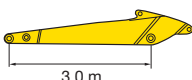
With 700 mm shoes

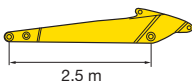
PC240LC-8 TWO-PIECE BOOM

Arm length	A		7,5 m		6,0 m		4,5 m		3,0 m		1,5 m		
	B												
 3,5 m  0,96 m³	6,0 m	kg	*2.350	*2.350	*4.900	4.200	*5.300	*5.300					
	4,5 m	kg	*2.350	*2.350	*5.850	4.100	*6.400	6.100	*6.350	*6.350			
	3,0 m	kg	*2.400	2.400	6.100	3.900	*8.400	5.700	*10.700	9.100	*16.350	*16.350	
	1,5 m	kg	*2.600	2.300	5.850	3.700	8.450	5.300	13.200	8.250			
	0,0 m	kg	*2.850	2.350	5.650	3.550	8.100	4.950	13.250	7.700	*6.650	*6.650	
	-1,5 m	kg	*3.300	2.550	5.550	3.450	7.950	4.800	13.000	7.500	*9.350	*9.350	
	-3,0 m	kg	*4.100	2.950	5.600	3.450	7.900	4.800	13.000	7.500	*13.350	*13.350	*16.400
-4,5 m	kg												
 3,0 m  0,96 m³	6,0 m	kg	*3.050	*3.050	*5.650	4.150	*6.150	*6.150	*5.650	*5.650			
	4,5 m	kg	*3.000	2.800	6.250	4.050	*7.450	6.000	*7.650	*7.650	*7.500	*7.500	
	3,0 m	kg	*3.050	2.550	6.050	3.900	8.850	5.650	*11.650	8.900			
	1,5 m	kg	*3.200	2.500	5.850	3.700	8.400	5.250	13.750	8.150			
	0,0 m	kg	*3.500	2.550	5.700	3.550	8.050	4.950	13.250	7.700			
	-1,5 m	kg	*4.000	2.800	5.650	3.500	8.000	4.900	13.100	7.600	*8.650	*8.650	
	-3,0 m	kg			5.700	3.550	7.950	4.850	13.200	7.700			*16.400
-4,5 m	kg												
 2,5 m  0,96 m³	6,0 m	kg	*4.850	3.700	6.250	4.050	*7.500	6.150	*7.650	*7.650			
	4,5 m	kg	*4.800	3.150	6.200	4.000	*8.350	*5.900	*10.150	9.500			
	3,0 m	kg	4.550	2.900	6.000	3.850	8.700	5.550	*12.600	8.650			
	1,5 m	kg	4.450	2.800	5.850	3.700	8.350	5.200	13.500	7.950			
	0,0 m	kg	4.600	2.900	5.700	3.600	8.000	4.900	13.150	7.650			
	-1,5 m	kg	5.050	3.150	5.700	3.550	8.050	4.950	13.100	7.600			
	-3,0 m	kg					8.100	5.000					
-4,5 m	kg												

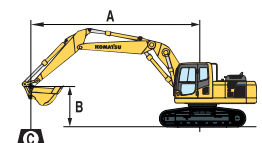

A – Reach from swing center

B – Bucket hook height

C – Lifting capacities, including bucket (730 kg), bucket linkage (200 kg) and bucket cylinder (140 kg)

 – Rating over front

 – Rating over side

















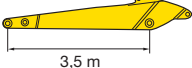

 – Rating at maximum reach

When removing bucket, linkage or cylinder, lifting capacities can be increased by their respective weights.

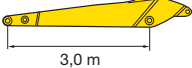
With 700 mm shoes

* Load is limited by hydraulic capacity rather than tipping. Ratings are based on SAE Standard No. J1097. Rated loads do not exceed 87% of hydraulic lift capacity or 75% of tipping load.

PC240NLC-8 MONO BOOM

Arm length	A		7,5 m		6,0 m		4,5 m		3,0 m		1,5 m	
	B											
 3,5 m 	6,0 m	kg	*2.350	*2.350	*4.050	3.800						
	4,5 m	kg	*2.400	*2.400	*5.050	3.700	*5.200	*5.200				
	3,0 m	kg	*2.550	*2.350	5.600	3.550	*6.550	5.200	*8.050	*8.050	*11.850	*11.850
	1,5 m	kg	*2.850	2.250	5.400	3.350	7.850	4.850	*10.850	7.600	*10.850	*10.850
	0,0 m	kg	*3.300	2.300	5.200	3.150	7.500	4.550	12.150	7.050	*9.500	*9.500
	-1,5 m	kg	*4.050	2.450	5.100	3.050	7.200	4.300	11.850	6.800	*11.850	*11.850
	-3,0 m	kg	4.750	2.850	5.100	3.050	7.250	4.300	11.850	6.750	*15.650	*13.550
-4,5 m	kg	6.250	3.800			7.350	4.400	12.000	6.900	*19.350	13.900	
												*14.400
												*14.400
 3,0 m 	6,0 m	kg	*3.000	*3.000	*4.450	3.750	*4.900	*4.900				
	4,5 m	kg	*3.050	2.800	*5.550	3.700	*5.800	5.500				
	3,0 m	kg	*3.200	2.550	5.600	3.550	*7.150	5.150	*9.050	8.200	*14.450	*14.450
	1,5 m	kg	*3.550	2.450	5.400	3.350	7.800	4.850	*11.700	7.500	*6.900	*6.900
	0,0 m	kg	*4.050	2.450	5.250	3.200	7.500	4.550	12.150	7.050	*8.100	*8.100
	-1,5 m	kg	*4.400	2.700	5.150	3.150	7.350	4.450	11.950	6.900	*11.650	*11.650
	-3,0 m	kg	5.200	3.200			7.350	4.450	11.950	6.900	*16.750	13.800
-4,5 m	kg	7.100	4.350			7.500	4.600	12.200	7.100	*18.350	14.250	
 2,5 m 	6,0 m	kg	*4.750	3.850			*5.650	5.600				
	4,5 m	kg	*4.850	3.200	6.700	3.800	*6.500	5.400	*7.500	*7.500		
	3,0 m	kg	4.600	2.850	5.550	3.500	*7.750	5.050	*10.150	8.000		
	1,5 m	kg	4.450	2.750	5.350	3.350	7.700	4.750	*12.450	7.300		
	0,0 m	kg	4.550	2.800	5.250	3.200	7.450	4.550	12.050	7.000		
	-1,5 m	kg	5.050	3.100	5.200	3.200	7.350	4.450	11.950	6.900	*13.000	*13.000
	-3,0 m	kg	6.100	3.750			7.400	4.500	12.050	7.000	*19.850	14.000
-4,5 m	kg	9.150	5.550					*11.700	7.250	*16.750	14.500	
 2,0 m 	6,0 m	kg	*4.850	4.250			*6.300	5.450				
	4,5 m	kg	*4.950	3.450	5.600	3.550	*7.100	5.300	*8.400	*8.400	*12.000	*12.000
	3,0 m	kg	4.950	3.100	5.450	3.450	7.950	5.000	*11.050	7.750		
	1,5 m	kg	4.800	2.950	5.350	3.300	7.650	4.700	12.250	7.150		
	0,0 m	kg	4.950	3.050	5.250	3.200	7.450	4.500	11.950	6.900		
	-1,5 m	kg	5.500	3.400			7.400	4.450	11.950	6.900	*13.550	*13.550
	-3,0 m	kg	6.950	4.250			7.500	4.550	12.150	7.050	*18.650	14.150
-4,5 m	kg	*9.750	6.850					*10.450	7.450			

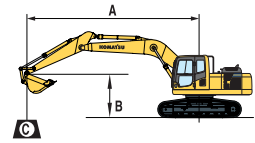

A – Reach from swing center

B – Bucket hook height

C – Lifting capacities, including bucket (730 kg), bucket linkage (200 kg) and bucket cylinder (140 kg)

 – Rating over front

















 – Rating over side

 – Rating at maximum reach

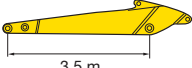
When removing bucket, linkage or cylinder, lifting capacities can be increased by their respective weights.

With 600 mm shoes

PC240NLC-8 TWO-PIECE BOOM

Arm length	A		7,5 m		6,0 m		4,5 m		3,0 m		1,5 m	
	B											
 3,5 m 	6,0 m	kg	*2.350	*2.350	*4.900	3.750	*5.300	*5.300				
	4,5 m	kg	*2.350	2.250	5.800	3.600	*6.400	5.400	*6.350	*6.350		
	3,0 m	kg	*2.400	2.050	5.600	3.400	8.200	5.000	*10.700	8.050	*16.350	*16.350
	1,5 m	kg	*2.600	2.000	5.350	3.200	7.750	4.650	12.600	7.200		
	0,0 m	kg	*2.850	2.000	5.200	3.050	7.400	4.300	11.950	6.650	*6.650	*6.650
	-1,5 m	kg	*3.300	2.150	5.100	2.950	7.250	4.150	11.700	6.450	*9.350	*9.350
	-3,0 m	kg	*4.100	2.550	5.100	2.950	7.200	4.150	11.750	6.500	*13.350	13.000
-4,5 m	kg											
 3,0 m 	6,0 m	kg	*3.050	2.800	*5.650	3.650	*6.150	5.550	*5.650	*5.650		
	4,5 m	kg	*3.000	2.400	5.750	3.550	*7.450	5.300	*7.600	*7.600	*7.400	*7.400
	3,0 m	kg	*3.050	2.200	5.550	3.400	8.100	4.950	*11.600	7.850		
	1,5 m	kg	*3.200	2.150	5.400	3.250	7.700	4.600	12.450	7.100		
	0,0 m	kg	*3.500	2.200	5.250	3.100	7.350	4.300	11.950	6.650		
	-1,5 m	kg	*4.000	2.400	5.150	3.050	7.300	4.250	11.800	6.550	*8.600	*8.600
	-3,0 m	kg			5.200	3.100	7.250	4.200	11.900	6.650		
-4,5 m	kg											
 2,5 m 	6,0 m	kg	*4.850	3.250	5.750	3.600	*7.500	5.450	*7.650	*7.650		
	4,5 m	kg	4.550	2.750	5.700	3.500	*8.350	5.200	*10.100	8.400		
	3,0 m	kg	4.200	2.500	5.550	3.200	8.000	4.850	*12.600	7.600		
	1,5 m	kg	4.100	2.450	5.350	3.200	7.650	4.550	12.200	6.900		
	0,0 m	kg	4.200	2.500	5.250	3.100	7.300	4.250	11.850	6.660		
	-1,5 m	kg	4.600	2.750	5.200	3.100	7.350	4.300	11.800	6.600		
	-3,0 m	kg					7.400	4.350				
-4,5 m	kg											

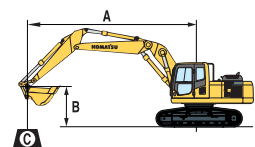

A – Reach from swing center

B – Bucket hook height

C – Lifting capacities, including bucket (730 kg), bucket linkage (200 kg) and bucket cylinder (140 kg)

 – Rating over front

 – Rating over side

 – Rating at maximum reach

When removing bucket, linkage or cylinder, lifting capacities can be increased by their respective weights.

With 600 mm shoes

* Load is limited by hydraulic capacity rather than tipping. Ratings are based on SAE Standard No. J1097. Rated loads do not exceed 87% of hydraulic lift capacity or 75% of tipping load.

Super Long Front Specification

WORK EQUIPMENT

Boom	
Length (a).....	10.530 mm
Height (b).....	1.545 mm
Weight.....	2.700 kg
Arm	
Length (c).....	9.325 mm
Height (d).....	1.200 mm
Weight.....	1.650 kg

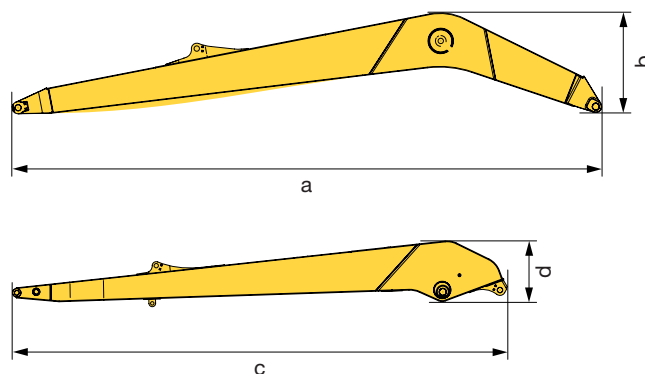

TRANSPORT DIMENSIONS

M	Transport length	14.400 mm
N	Length on ground (transport)	4.520 mm
O	Overall height (to top of boom)	3.230 mm

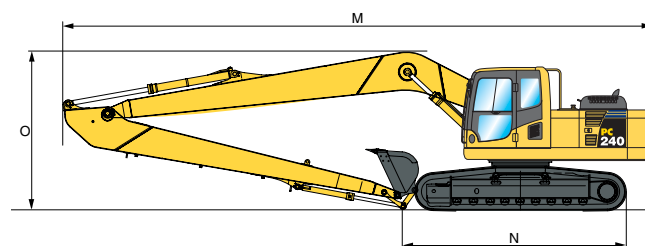

MAX. BUCKET CAPACITY AND WEIGHT

	PC240LC-8		PC240NLC-8	
General purpose bucket				
Max. bucket width	955 mm			
Material weight up to 1,2 t/m ³	0,63 m ³	500 kg	0,51 m ³	450 kg
Material weight up to 1,5 t/m ³	0,54 m ³	475 kg	0,44 m ³	410 kg
Material weight up to 1,8 t/m ³	0,47 m ³	425 kg	0,38 m ³	375 kg
Ditch cleaning bucket				
Max. bucket width	2.100 mm			
Material weight up to 1,2 t/m ³	* 1.300 kg		* 1.000 kg	
Material weight up to 1,5 t/m ³	* 1.300 kg		* 1.000 kg	
Material weight up to 1,8 t/m ³	-		-	

* Maximum load at end of arm (bucket + payload).

Max. capacity and weight have been calculated according to ISO 10567:2007.

Please consult with your distributor for the correct selection of buckets and attachments to suit the application.

OPERATING WEIGHT (APPR.)

	PC240LC-8		PC240NLC-8	
	Operating weight	Ground pressure	Operating weight	Ground pressure
Triple grouser shoes				
600 mm	27.610 kg	0,58 kg/cm ²	26.910 kg	0,61 kg/cm ²
700 mm	27.910 kg	0,50 kg/cm ²	27.210 kg	0,53 kg/cm ²
800 mm	28.210 kg	0,45 kg/cm ²	-	-
900 mm	28.510 kg	0,40 kg/cm ²	-	-

Operating weight, including Super Long Front work equipment, bucket, operator, lubricant, coolant, full fuel tank and the standard equipment.



Working range PC240LC/NLC-8 Super Long Front

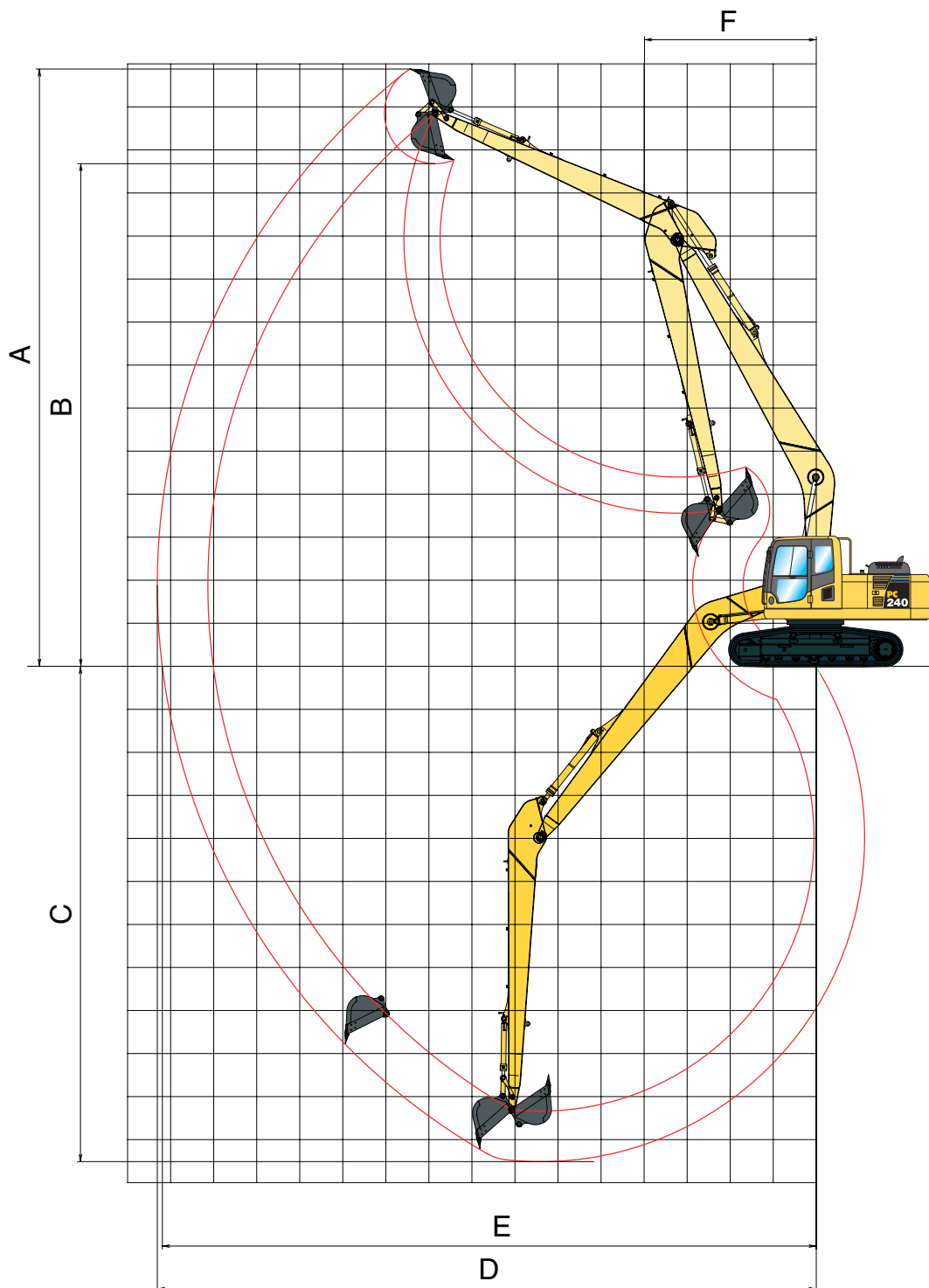

SUPER LONG FRONT

A	Max. digging height	14.970 mm
B	Max. dumping height	12.860 mm
C	Max. digging depth	14.580 mm
D	Max. digging reach	18.300 mm
E	Max. digging reach at ground level	18.250 mm
F	Min. swing radius	5.220 mm

Super Long Front Specification

Lifting capacity PC240LC-8 Super Long Front

A – Reach from swing center

B – Bucket hook height

C – Lifting capacities, including bucket (278 kg)

 – Rating over front







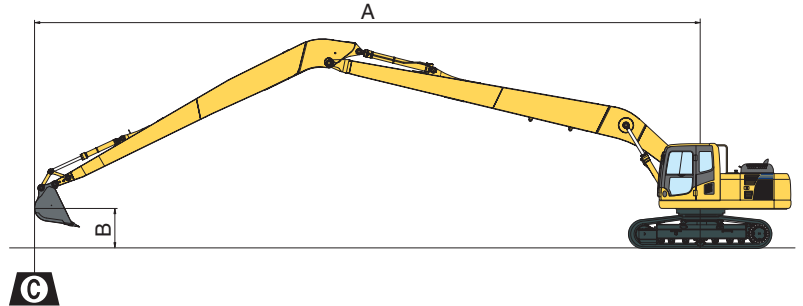





 – Rating over side

 – Rating at maximum reach

When removing bucket, linkage or cylinder, lifting capacities can be increased by their respective weights.



With 700 mm shoes

A			17,0 m		13,0 m		11,0 m		9,0 m		7,0 m	
												
14,0 m kg	900*	900*										
10,0 m kg	850*	850*			1.700*	1.700*						
6,0 m kg	850*	850*	850*	850*	2.000*	2.000*	2.050*	2.050*				
3,0 m kg	950*	950*	1.350*	1.050	2.400*	2.000	2.700*	2.700*	3.100*	3.100*	3.800*	3.800*
0,0 m kg	1.100*	900	1.500*	950	2.800	1.700	3.350*	2.300	4.150*	3.200	5.600*	4.550
-3,0 m kg	1350*	900			2.600	1.500	3.350	2.000	4.450	2.700	6.400	3.850
-6,0 m kg	1.800*	1.050			2.450	1.400	3.150	1.850	4.250	2.500	6.150	3.600
-9,0 m kg	2.350	1.350			2.500	1.450	3.200	1.850	4.250	2.550	6.250	3.700
-13,0 m kg	3.900*	2.850							4.000*	2.900	5.300*	4.200

* Load is limited by hydraulic capacity rather than tipping. Ratings are based on SAE Standard No. J1097. Rated loads do not exceed 87% of hydraulic lift capacity or 75% of tipping load. Lifting capacity table is published for guidance only, the machine is not intended for use as a crane.

Lifting capacity PC240NLC-8 Super Long Front

A – Reach from swing center

B – Bucket hook height

C – Lifting capacities, including bucket (278 kg)

 – Rating over front







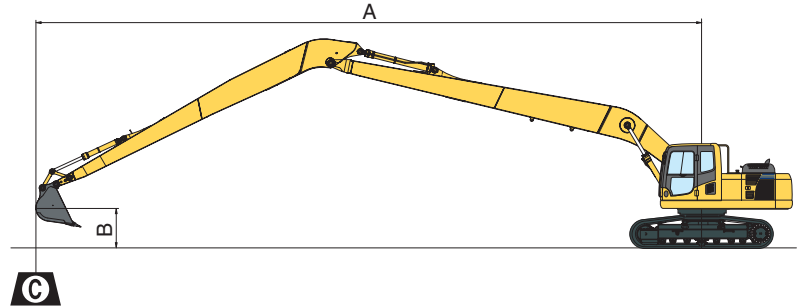





 – Rating over side

 – Rating at maximum reach

When removing bucket, linkage or cylinder, lifting capacities can be increased by their respective weights.



With 600 mm shoes

A			17,0 m		13,0 m		11,0 m		9,0 m		7,0 m	
B												
14,0 m kg	900*	900*										
10,0 m kg	850*	850*			1.700*	1.700*						
6,0 m kg	850*	850*	850*	850*	2.000*	1.950	2.050*	2.050*				
3,0 m kg	950*	800	1.350*	850	2.400*	1.700	2.700*	2.400	3.100*	3.100*	3.800*	3.800*
0,0 m kg	1.100*	700	1.500	750	2.450	1.450	3.250	2.000	4.150*	2.750	5.600*	3.950
-3,0 m kg	1.350*	700			2.250	1.250	2.950	1.650	3.950	2.300	5.650	3.250
-6,0 m kg	1.600	800			2.150	1.150	2.750	1.500	3.700	2.100	5.400	3.050
-9,0 m kg	2.050	1.100			2.200	1.150	2.800	1.550	3.750	2.100	5.500	3.100
-13,0 m kg	3.900*	2.450							4.000*	2.500	5.300*	3.600

* Load is limited by hydraulic capacity rather than tipping. Ratings are based on SAE Standard No. J1097. Rated loads do not exceed 87% of hydraulic lift capacity or 75% of tipping load. Lifting capacity table is published for guidance only, the machine is not intended for use as a crane.

Hydraulic Excavator

PC240LC/NLC-8

Standard and Optional Equipment

ENGINE

Komatsu SAA6D107E-1 turbocharged common rail direct injection diesel engine	●
EU Stage IIIA/EPA Tier III compliant	●
Suction type cooling fan with radiator fly screen	●
Automatic engine warm-up system	●
Engine overheat prevention system	●
Fuel control dial	●
Auto-deceleration function	●
Engine key stop	●
Engine ignition can be password secured on request	●
Alternator 24 V/60 A	●
Starter motor 24 V/5,5 kW	●
Batteries 2 × 12 V/140 Ah	●
Diesel particulate filter	○

HYDRAULIC SYSTEM

Electronic closed-centre load sensing (E-CLSS) hydraulic system (HydrauMind)	●
Pump and engine mutual control (PEMC) system	●
One additional hydraulic circuit (optional with Super Long Front)	●
5-working mode selection system; power mode, economy mode, breaker mode, attachment mode and lifting mode	●
PowerMax function	●
Adjustable PPC wrist control levers for arm, boom, bucket and swing, with sliding proportional control for attachments and 3 auxiliary buttons	●
Prepared for hydraulic quick-coupler (not with Super Long Front)	●
Additional hydraulic functions (not with Super Long Front)	○

UNDERCARRIAGE

Track roller guards	●
Track frame under-guards	●
LC and NLC undercarriages	○
600, 700, 800, 900 mm triple grouser track-shoes	○
Full length track roller guards	○

CABIN

Reinforced safety SpaceCab™; highly pressurised and tightly sealed hyper viscous mounted cab with tinted safety glass windows, large roof window with sun shade, pull-up type front window with locking device, removable lower window, front window wiper with intermittent feature, sun roller blind, cigarette lighter, ashtray, luggage shelf, floor mat	●
Heated air suspension seat with lumbar support, height adjustable arm rests and retractable seat belt	●
Automatic climate control system	●
12 Volt power supply	●
Beverage holder and magazine rack	●
Hot and cool box	●
Radio	●
Lower wiper	○
Rain visor (not with OPG)	○

SERVICE AND MAINTENANCE

Automatic fuel line de-aeration	●
Double element type air cleaner with dust indicator and auto dust evacuator	●
KOMTRAX™ - Komatsu satellite monitoring system	●
Multi-function video compatible colour monitor with Equipment Management and Monitoring System (EMMS) and efficiency guidance	●
Toolkit and spare parts for first service	●
Automatic greasing system	○
Service points	○

WORK EQUIPMENT

Mono boom	○
Two-piece boom	○
Super Long Front boom and arm (18 m)	○
2,0 m; 2,5 m; 3,0 m; 3,5 m arms	○
Bucket linkage with lifting eye	○
Komatsu buckets	○
Komatsu breakers	○

SAFETY EQUIPMENT

Rear view camera system	●
Electric horn	●
Overload warning device	●
Lockable fuel cap and covers	●
Audible travel alarm	●
Boom safety valves	●
Large handrails, rear-view mirrors	●
Battery main switch	●
Arm safety valve (not with Super Long Front)	○
OPG Level II front guard (FOPS)	○
OPG Level II top guard (FOPS)	○

DRIVES AND BRAKES

Hydrostatic, 3-speed travel system with automatic shift and planetary gear type final drives, and hydraulic travel and parking brakes	●
PPC control levers and pedals for steering and travel	●

LIGHTING SYSTEM

Working lights: 2 revolving frame, 2 cab roof (front), 1 boom (l.h.)	●
Additional working lights: 2 cab roof (front), 1 cab roof (rear), 1 boom (r.h.), 1 counterweight (rear), 1 beacon	○

OTHER EQUIPMENT

Standard counterweight	●
Heavy counterweight (with Super Long Front)	●
Remote greasing for swing circle and pins	●
Electric refuelling pump with automatic shut off function	●
Standard colour scheme and decals	●
Parts book and operator manual	●
Biodegradable oil for hydraulic system	○
Customised paint	○

Further equipment on request

- standard equipment
- optional equipment

Your Komatsu partner:

KOMATSU

Komatsu Europe International NV
 Mechelsesteenweg 586
 B-1800 VILVOORDE (BELGIUM)
 Tel. +32-2-255 24 11
 Fax +32-2-252 19 81
www.komatsu.eu

UESS11405 01/2010

Materials and specifications are subject to change without notice.
KOMATSU is a trademark of Komatsu Ltd. Japan.